Telemecanique Sensors Detection components

Panorama 2024



Designed for small spaces in packaging machines



Simply easy!™

Telemecanique Sensors

Simply easy!™

Founded over 90 years ago, Telemecanique Sensors is specialized in sensors and sensor-related technology. As a global leader in the sensors business, we help our customers select the right technology to get the best performance and reliability from their machines.



Focused on 3 core values – **Simplicity, Proximity and Expertise** – we have become experts in factory automation sensors as well as specialists in demanding applications, making our customers' lives “Simply easy!”

Visit our website and discover our full offer on www.telemecaniquesensors.com

Telemecanique Sensors presents an expanded XU range of application photo-electric sensors to be embedded in automated lines for the packaging market segment. With their diverse technical characteristics, high performance and smart management capabilities, they are designed to address a wide scope of specific needs.



Sensor family per application

- > Marking detection
- > Very dark and light-absorbing object detection
- > Accurate detection
- > Colour object detection, from simple colour to very complex colour sorting
- > Transparent object detection, with or without reflector



Laser



Red light



White light



Blue light



RGB

Five light spots

Choose the casing, connection type and size

- > Plastic or metal casing
- > Pre-cabled, with pigtail or connector
- > Miniature, sub-miniature and compact size

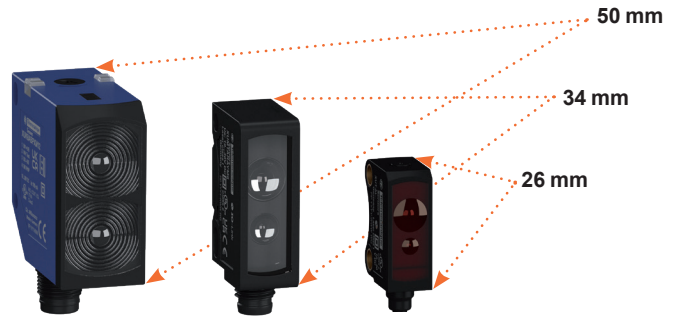

Enable smart sensors
functions through IO-Link



Smart devices communicate via IO-Link protocol

- > Install your new IO-Link sensor easily: automatic reading of the device identification file (IODD) and automatic detection of the sensor output mode
- > Automated parameter settings: configure the detection parameters
- > Extended diagnostics, with real-time information for optimised usage and maintenance



SPOTLIGHT: Photoelectric sensors XUM XUB XUN

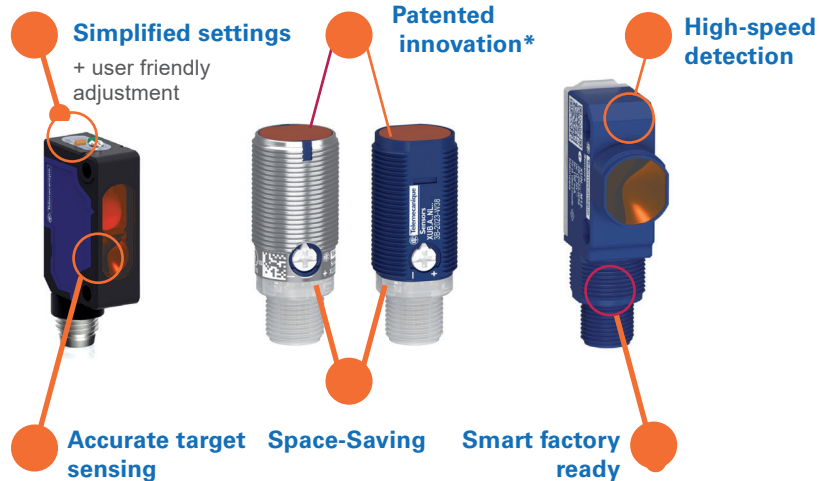

*Small reflector placed on "thru beam" sensors, reaching up to 30m, enabling the user to align the sensors in less than 4 minutes (compared to 15 minutes previously). This reduces installation time by a factor of 3!

Pressure switches: XM Range

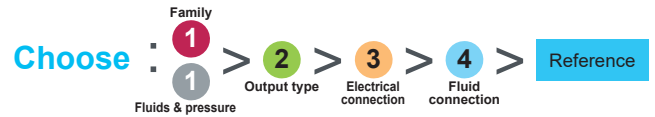

XMLP Electronic transmitter		Hydraulic oils, air, fresh water		
M12 4 pin (male)		-30...+85° C		
		Analog output		
		4...20 mA	0...10 V	0.5...4.5 V
Bar	psi			
-1	-14.5	XMLPM00GD21F	XMLPM00GD71F	XMLPM00GD11F
1	14.5	XMLP001GD21F	XMLP001GD71F	XMLP001GD11F
6	87	XMLP006GD21F	XMLP006GD71F	XMLP006GD11F
10	145	XMLP010BD21F	XMLP010BD71F	XMLP010BD11F
16	232	XMLP016BD21F	XMLP016BD71F	XMLP016BD11F
25	362	XMLP025BD21F	XMLP025BD71F	XMLP025BD11F
40	580	XMLP040BD21F	XMLP040BD71F	XMLP040BD11F
60	870	XMLP060BD21F	XMLP060BD71F	XMLP060BD11F
100	1450	XMLP100BD21F	XMLP100BD71F	XMLP100BD11F
160	2320	XMLP160BD21F	XMLP160BD71F	XMLP160BD11F
250	3625	XMLP250BD21F	XMLP250BD71F	XMLP250BD11F
400	5800	XMLP400BD21F	XMLP400BD71F	XMLP400BD11F
600	8700	XMLP600BD21F	XMLP600BD71F	XMLP600BD11F

ZMLP Display and switch	4-20 mA analog + switching output		2 switching outputs	
M12 4 pin (male)	NO/NC Programmable		NO/NC Programmable	
PNP	Window	Hysteresis	Fixed hysteresis	
	ZMLPA1P2SW	ZMLPA1P2SH	ZMLPA2P0SH	

Only usable with 4-20mA analog output XMLP electronic transmitter

Quick mounting bracket	Horizontal plan	Vertical plan or pipe
	XMLPZLH01	XMLPZLV01

Cabling XM

		Connectors (female)		PUR pre wired connectors (female) (3)			PUR Jumper cables					
M12		straight	elbowed	M12	straight	elbowed	elbowed PNP LED	M12 (female)	straight	elbowed		
(1)	4 pin	XZCC12FDM40B	XZCC12FCM40B	4 pin	2 m	XZCP1141L2	XZCP1241L2	XZCP1340L2	M12 (male)	straight	straight	
(2)	4 pin	XZCC12FDP40B	XZCC12FCP40B		5 m	XZCP1141L5	XZCP1241L5	XZCP1340L5	4 pin	1 m	XZCR1511041C1	XZCR1512041C1
(1)	5 pin	XZCC12FDM50B	XZCC12FCM50B		10 m	XZCP1141L10	XZCP1241L10	XZCP1340L10		2 m	XZCR1511041C2	XZCR1512041C2

(1) Steel ring (2) Plastic ring (3) For a PVC cable, add the letter V after the P. Example: XZCPpppppp become XZCPVpppppp

Pressure switches: XM Range

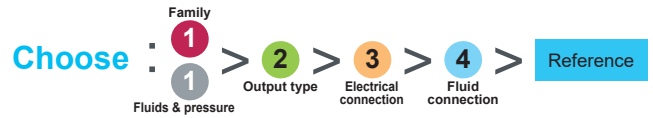

XMLA / XMLB Electromechanical		Hydraulic oils, air, fresh water, sea water / Temp. : up to 70° C							
Screw terminal		1 C/O single pole contact fixed differential			1 C/O single pole contact adjustable differential				
		Bar	psi	ISO M20	Pg13	DIN connector	ISO M20	Pg13	DIN connector
		-1	-14.5	XMLAM01V2S12	XMLAM01V2S11	XMLAM01V2C11	XMLBM02V2S12	XMLBM02V2S11	XMLBM02V2C11
		2.5	36.3	XMLA002A2S12	XMLA002A2S11	XMLA002A2C11	XMLB002A2S12	XMLB002A2S11	XMLB002A2C11
		4	58	XMLA004A2S12	XMLA004A2S11	XMLA004A2C11	XMLB004A2S12	XMLB004A2S11	XMLB004A2C11
		10	145	XMLA010A2S12	XMLA010A2S11	XMLA010A2C11	XMLB010A2S12	XMLB010A2S11	XMLB010A2C11
		20	290	XMLA020A2S12	XMLA020A2S11	XMLA020A2C11	XMLB020A2S12	XMLB020A2S11	XMLB020A2C11
		35	508	XMLA035A2S12	XMLA035A2S11	XMLA035A2C11	XMLB035A2S12	XMLB035A2S11	XMLB035A2C11
		Hydraulic oils / Temp. : up to 160° C							
G 1/4 (female)		1	14.5	XMLA001R2S12	XMLA001R2S11	XMLA001R2C11	XMLB001R2S12	XMLB001R2S11	XMLB001R2C11
		70	1015	XMLA070D2S12	XMLA070D2S11	XMLA070D2C11	XMLB070D2S12	XMLB070D2S11	XMLB070D2C11
		160	2320	XMLA160D2S12	XMLA160D2S11	XMLA160D2C11	XMLB160D2S12	XMLB160D2S11	XMLB160D2C11
		300	4350	XMLA300D2S12	XMLA300D2S11	XMLA300D2C11	XMLB300D2S12	XMLB300D2S11	XMLB300D2C11
		500	7250	XMLA500D2S12	XMLA500D2S11	XMLA500D2C11	XMLB500D2S12	XMLB500D2S11	XMLB500D2C11

XMLR Electronic + Display		Hydraulic oils, air, fresh water, refrigerant fluids					
M12 4 pin or 5 pin		-20... +80° C		Analog output		Analog + 2 switching outputs PNP - NO/NC programmable 4...20 mA	
		Bar	psi	4...20 mA	0...10 V		
		-1	-14.5	XMLRM01G0T25	XMLRM01G0T75	XMLRM01G2P25	
		1	14.5	XMLR001G0T25	XMLR001G0T75		
		2.5	35.2	XMLR2D5G0T25	XMLR2D5G0T75		
		10	145	XMLR010G0T25	XMLR010G0T75	XMLR010G2P25	
		16	232	XMLR016G0T25	XMLR016G0T75	XMLR016G2P25	
		25	362	XMLR025G0T25	XMLR025G0T75		
		40	580	XMLR040G0T25	XMLR040G0T75	XMLR040G2P25	
		100	1450	XMLR100M0T25	XMLR100M0T75		
		160	2320	XMLR160M0T25	XMLR160M0T75		
		250	3625	XMLR250M0T25	XMLR250M0T75	XMLR250M2P25	
	400	5800	XMLR400M0T25	XMLR400M0T75	XMLR400M2P25		
	600	8700	XMLR600M0T25	XMLR600M0T75			

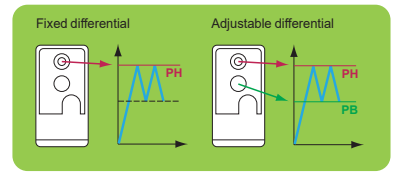

		Hydraulic oils, air, fresh water, refrigerant fluids					
G 1/4A (female)		-20... +80° C		Analog + switching output PNP - NO/NC programmable		2 switching outputs PNP - NO/NC programmable	
		Bar	psi	4...20 mA	0...10 V		
		-1	-14.5	XMLRM01G1P25	XMLRM01G1P75	XMLRM01G2P05	
		1	14.5	XMLR001G1P25	XMLR001G1P75	XMLR001G2P05	
		2.5	35.2	XMLR2D5G1P25	XMLR2D5G1P75	XMLR2D5G2P05	
		10	145	XMLR010G1P25	XMLR010G1P75	XMLR010G2P05	
		16	232	XMLR016G1P25	XMLR016G1P75	XMLR016G2P05	
		25	362	XMLR025G1P25	XMLR025G1P75	XMLR025G2P05	
		40	580	XMLR040G1P25	XMLR040G1P75	XMLR040G2P05	
		100	1450	XMLR100M1P25	XMLR100M1P75	XMLR100M2P05	
		160	2320	XMLR160M1P25	XMLR160M1P75	XMLR160M2P05	
		250	3625	XMLR250M1P25	XMLR250M1P75	XMLR250M2P05	
		400	5800	XMLR400M1P25	XMLR400M1P75	XMLR400M2P05	
		600	8700	XMLR600M1P25	XMLR600MP75	XMLR600M2P05	

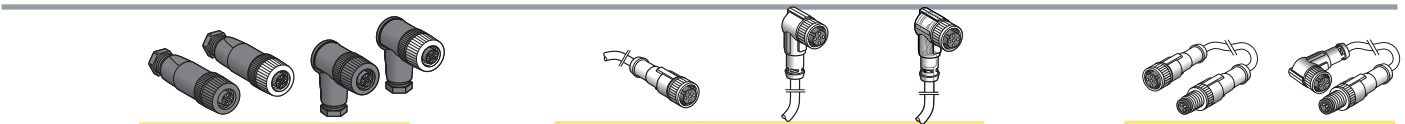

Cabling XM			Connectors (female)			PUR pre wired connectors (female) (3)			PUR Jumper cables				
M12	straight	elbowed	M12	straight	elbowed	elbowed PNP LED	M12 (female)	straight	elbowed	M12 (male)	straight	elbowed	
(1)	4 pin	XZCC12FDM40B	XZCC12FCM40B	4 pin	2 m	XZCP1141L2	XZCP1241L2	XZCP1340L2		4 pin	1 m	XZCR1511041C1	XZCR1512041C1
(2)	4 pin	XZCC12FDP40B	XZCC12FCP40B		5 m	XZCP1141L5	XZCP1241L5	XZCP1340L5			2 m	XZCR1511041C2	XZCR1512041C2
(1)	5 pin	XZCC12FDM50B	XZCC12FCM50B		10 m	XZCP1141L10	XZCP1241L10	XZCP1340L10					

(1) Steel ring (2) Plastic ring

(3) For a PVC cable, add the letter V after the P. Example: XZCPpppppp become XZCPVpppppp

Limit switches: XC Range

Choose: **1** > **2** > **3** > **4** > Reference
 Body Head Contact Connection

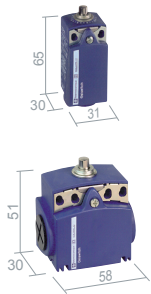

XCKD Metal	NO+NC Snap	M16	XCKD2110P16	XCKD2102P16	XCKD2121P16	XCKD2106P16	XCKD2118P16	XCKD2145P16						
		Pg11	XCKD2110G11	XCKD2102G11	XCKD2121G11	XCKD2106G11	XCKD2118G11	XCKD2145G11						
		M12 5P	XCKD2110M12	XCKD2102M12	XCKD2121M12	XCKD2106M12	XCKD2118M12	XCKD2145M12						
XCKP Plastic	NO+NC Snap	M16	XCKP2110P16	XCKP2102P16	XCKP2121P16	XCKP2106P16	XCKP2118P16	XCKP2145P16						
		Pg11	XCKP2110G11	XCKP2102G11	XCKP2121G11	XCKP2106G11	XCKP2118G11	XCKP2145G11						
		M12 4P	XCKP2110M12	XCKP2102M12	XCKP2121M12	XCKP2106M12	XCKP2118M12	XCKP2145M12						
XCKT Plastic	NO+NC Snap	M16	XCKT2110P16	XCKT2102P16	XCKT2121P16	XCKT2106P16	XCKT2118P16	XCKT2145P16						
		Pg11	XCKT2110G11	XCKT2102G11	XCKT2121G11	XCKT2106G11	XCKT2118G11	XCKT2145G11						



XCMD Metal	NO+NC Snap	1 m	XCMD2110L1	XCMD2102L1	XCMD2124L1	XCMD21F0L1	XCMD21F2L1	XCMD2115L1	XCMD2116L1	
	NO+NC Slow	1 m	XCMD2510L1	XCMD2502L1	XCMD2524L1	XCMD25F0L1	XCMD25F2L1	XCMD2515L1	XCMD2516L1	
	NO+NC Snap	M12 5P	XCMD2110C12	XCMD2102C12	XCMD2124C12	XCMD21F0C12	XCMD21F2C12	XCMD2115C12	XCMD2116C12	
	1 C/O Snap	M12 4P	XCMD2110M12	XCMD2102M12	XCMD2124M12	XCMD21F0M12	XCMD21F2M12	XCMD2115M12	XCMD2116M12	



			Type of operator	Metal end plunger	Steel roller plunger	2NC+2NO Snap	Type of operator	Metal end plunger	Steel roller plunger
XCSM Metal	Safety contacts (3)	Cable 1m		XCSM3710L1	XCSM3702L1			XCSM4110L1	XCSM4102L1
		Cable 2m		XCSM3710L2	XCSM3702L2			XCSM4110L2	XCSM4102L2
	2NC+NO Slow	Cable 2m		XCSM3710L2	XCSM3702L2			XCSM4110L2	XCSM4102L2
		Cable 5m		XCSM3710L5	XCSM3702L5			XCSM4110L5	XCSM4102L5



XCKM Metal	NO+NC Snap	M20	XCKM110H29	XCKM102H29	XCKM121H29	XCKM115H29	XCKM106H29				
		Pg11	XCKM110	XCKM102	XCKM121	XCKM115	XCKM106				
XCKL Metal	NO+NC Snap	CG	XCKL110	XCKL102	XCKL121	XCKL115	XCKL106				



XCKJ Metal	NO+NC Snap	M20	XCKJ161H29	XCKJ167H29	XCKJ10511H29	XCKJ10513H29	XCKJ10541H29	XCKJ10559H29						
		Pg13	XCKJ161	XCKJ167	XCKJ10511	XCKJ10513	XCKJ10541	XCKJ10559						
		1/2NPT	XCKJ161H7	XCKJ167H7	XCKJ10511H7	XCKJ10513H7	XCKJ10541H7	XCKJ10559H7						
		M12 5P	XCKJ161D	XCKJ167D	XCKJ10511D	XCKJ10513D	XCKJ10541D	XCKJ10559D						

(1) Plastic roller (2) Steel roller

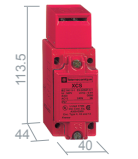

			NC+2NO Slow	2NC+NO Slow	3NC Slow	Accessories	
XCSA Metal	M20		XCSA502	XCSA702	XCSA802	XCSZ01	XCSZ03
	Pg13		XCSA501	XCSA701	XCSA801		
	1/2NPT		XCSA503	XCSA703	XCSA803		

			NC+NO Slow	2NC Slow	2NO+NC Slow	2NC+NO Slow	2NC+NO Snap	Accessories	
XCSPA Plastic	M16		XCSPA592	XCSPA792	XCSPA892	XCSPA992	XCSPA492	XCSZ11	XCSZ13
	Pg11		XCSPA591	XCSPA791	XCSPA891	XCSPA991	XCSPA491		
	1/2NPT		XCSPA593	XCSPA793	XCSPA893	XCSPA993	XCSPA493		

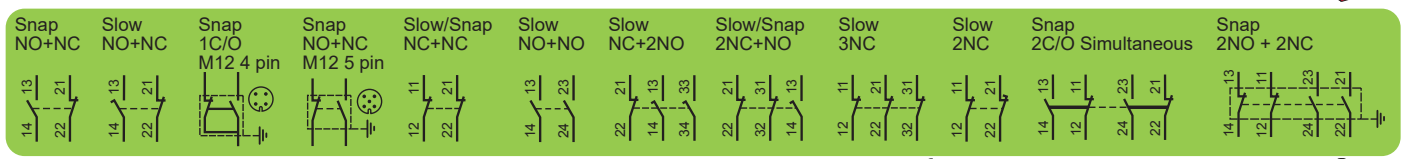

- M16 Tapped M16x1.5 for ISO cable gland
- M20 Tapped M20x1.5 for ISO cable gland
- Pg11 Tapped for a N°11 cable gland
- Pg13 Tapped for a N°13 cable gland
- 1/2NPT Tapped for a 1/2" NPT
- PF1/2 Tapped for a PF1/2"
- M12 5P Connector M12, 5 pin
- M12 4P Connector M12, 4 pin
- CG Tapped with cable gland included

Cabling XC		PUR pre wired connectors			Connectors (female)		
		straight	elbowed	elbowed PNP LED	M12 straight	elbowed	
M12	4 pin	XZCP1141L2	XZCP1241L2	XZCP1340L2	(2) 4 pin	XZCC12FDM40B	XZCC12FCM40B
	5 m	XZCP1141L5	XZCP1241L5	XZCP1340L5	(3) 4 pin	XZCC12FDP40B	XZCC12FCP40B
	10 m	XZCP1141L10	XZCP1241L10	XZCP1340L10	(2) 5 pin	XZCC12FDM50B	XZCC12FCM50B
	5 pin	XZCP1164L5	XZCP1264L5				

(1) For a PVC cable, add the letter V after the P. Example: XZCPpppppp become

Limit switches: XC Range

XCKP / XCKD / XCKT

Plastic / Metal / Plastic

	NO+NC Snap	NO+2NC Snap	NO+NC Slow	NC+NC Slow	NC+NC Snap	NO+NO Slow
XCKP	ZCP21	ZCP39	ZCP25	ZCP27	ZCP29	ZCP28
XCKD	ZCD21	ZCD39	ZCD25	ZCD27	ZCD29	ZCD28

Cable entry	M16	M20	Pg11	Pg13.5	1/2 NPT	PF1/2
XCKP	ZCPEP16	ZCPEP20	ZCPEG11	ZCPEG13	ZCPEN12	ZCPEF12
XCKD	ZCDEP16	ZCDEP20	ZCDEG11	ZCDEG13	ZCDEN12	ZCDEF12

	NO+NC Snap		XCKT	NC+NC Snap
M12 4P	ZCP21M12		M16	ZCT21P16
M12 5P	ZCD21M12		Pg11	ZCT21G11
				NO+NC Slow
			M16	ZCT25P16
			Pg11	ZCT25G11

XCMD

Metal

	NO+NC Snap	NO+NC Slow	2NO+2NC Snap	NO+NC Snap	1C/O Snap
ZCMD21		ZCMD25	ZCMD4D	ZCMD21C12	ZCMD21M12

1 m	ZCMC21L1	ZCMD21L1	ZCMC25L1	ZCMD25L1	ZCMC4D1	ZCMD41L1
2 m	ZCMC21L2	ZCMD21L2	ZCMC25L2	ZCMD25L2	ZCMC4D2	ZCMD41L2
5 m	ZCMC21L5	ZCMD21L5	ZCMC25L5	ZCMD25L5	ZCMC4D5	ZCMD41L5

XCKM / XCKL

Metal

XCKM/XCKL	NO+NC Snap	NO+NC Slow
3xPg11	ZCKM1	ZCKM5
3xM20	ZCKM1H29	ZCKM5H29
PE		ZCKL1
1/2 NPT		ZCKL1H7
		ZCKL5
		ZCKL5H7

XCKS	NO+NC Snap	NO+NC Slow
Pg13	ZCKS1	ZCKS5
M20	ZCKS1H29	ZCKS5H29

XCKJ	NO+NC Snap	NO+NC Slow	2C/O Simult. Snap
Pg13	ZCKJ1	ZCKJ5	ZCKJ2
M20	ZCKJ1H29	ZCKJ5H29	ZCKJ2H29
1/2 NPT	ZCKJ1H7	ZCKJ5H7	ZCKJ2H7
M12 5P	ZCKJ1D	ZCKJ5D	-

XCKJ

Metal

ZCKE05	ZCKY41	ZCKY43	ZCKY59	ZCKY51	ZCKY53
--------	--------	--------	--------	--------	--------

XCKS

Plastic

ZCKD01	ZCKD02	ZCKD05	ZCKY31	ZCKY39	ZCKY41
--------	--------	--------	--------	--------	--------

Inductives: XS Range

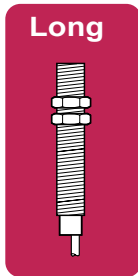
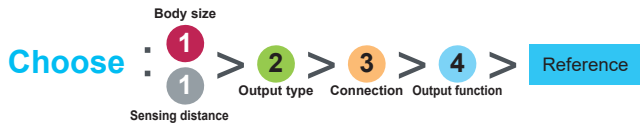

			M8		M12	
Sensing distance			1.5 mm	2.5 mm	2 mm	4 mm
DC3	PNP	cable	XS508B1PAL2	XS108B3PAL2	XS512B1PAL2	XS112B3PAL2
		connector	XS508B1PAM8	XS108B3PAM8	XS512B1PAM12	XS112B3PAM12
	NPN	cable	XS508B1NAL2	XS108B3NAL2	XS512B1NAL2	XS112B3NAL2
		connector	XS508B1NAM8	XS108B3NAM8	XS512B1NAM12	XS112B3NAM12
DC2		cable	XS508BSCAL2	XS608B3CAL2	XS512BSDAL2	XS612B3DAL2
		connector	XS508BSCAL01M12	XS608B3CAL01M12	XS512BSDAM12	XS612B3DAM12
DC3	PNP	cable	XS508BLPAL2	XS608B1PAL2	XS512BLPAL2	XS612B1PAL2
		connector	XS508BLPAM12	XS608B1PAM12	XS512BLPAM12	XS612B1PAM12
	NPN	cable	XS508BLNAL2	XS608B1NAL2	XS512BLNAL2	XS612B1NAL2
		connector	XS508BLNAM12	XS608B1NAM12	XS512BLNAM12	XS612B1NAM12
DC2		cable	XS508B1DAL2	XS608B1DAL2	XS512B1DAL2	XS612B1DAL2
		connector	XS508B1DAM12	XS608B1DAM12	XS512B1DAM12	XS612B1DAM12
AC/DC		cable			XS512B1MAL2	XS612B1MAL2
		connector			XS512B1MAU20	XS612B1MAU20
Output function		NO		A		A
		NC		B		B
		NO + NC				(short only) C

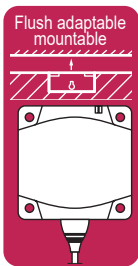
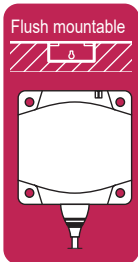

			U 8x22x8 mm	U 15x32x8 mm	U 26x26x13 mm	U 40x40x15 mm
Sensing distance			2.5 mm	5 mm	10 mm	15 mm
DC3	PNP	cable	XS7J1A1PAL2	XS7F1A1PAL2	XS7E1A1PAL2	XS7C1A1PAL2
		connector	XS7J1A1PAL01M8	XS7F1A1PAL01M8	XS7E1A1PAM8	XS7C1A1PAM8
	NPN	cable	XS7J1A1NAL2	XS7F1A1NAL2	XS7E1A1NAL2	XS7C1A1NAL2
		connector	XS7J1A1NAL01M8	XS7F1A1NAL01M8	XS7E1A1NAM8	XS7C1A1NAM8
DC2		cable	XS7J1A1DAL2	XS7F1A1DAL2	XS7E1A1DAL2	XS7C1A1DAL2
		connector	XS7J1A1DAL01M8	XS7F1A1DAL01M8	XS7E1A1DAM8	XS7C1A1DAM8
DC3	PNP	cable				
		connector				
	NPN	cable				
		connector				
AC/DC		cable				
		connector				
Output function		NO		A		A
		NC		B		B

XSppppppM8:
Connector M8 3 pin

XSppppppM12:
Connector M12 4 pin

XSppppppU20:
Connector 1/2" 3 pin

Cabling XS

		PUR pre wired connectors (female) (1)		
		straight	elbowed	
M8	3 pin	2 m	XZCP0566L2	XZCP0666L2
		5 m	XZCP0566L5	XZCP0666L5
		10 m	XZCP0566L10	XZCP0666L10
1/2"	3 pin	5 m	XZCP1865L5	XZCP1965L5

(1) For a PVC cable, add the letter V after the P. Example: XZCPpppppp become XZCPVpppppp

Inductives: XS Range



Flush mountable

Short

Long

			M18		M30	
Sensing distance			5 mm	8 mm	10 mm	15 mm
DC3	PNP	cable	XS518B1PAL2	XS118B3PAL2	XS530B1PAL2	XS130B3PAL2
		connector	XS518B1PAM12	XS118B3PAM12	XS530B1PAM12	XS130B3PAM12
	NPN	cable	XS518B1NAL2	XS118B3NAL2	XS530B1NAL2	XS130B3NAL2
		connector	XS518B1NAM12	XS118B3NAM12	XS530B1NAM12	XS130B3NAM12
DC2	cable	XS518BSDAL2	XS618B3DAL2	XS530BSDAL2	XS630B3DAL2	
	connector	XS518BSDAM12	XS618B3DAM12	XS530BSDAM12	XS630B3DAM12	
DC3	PNP	cable	XS518BLPAL2	XS618B1PAL2	XS530BLPAL2	XS630B1PAL2
		connector	XS518BLPAM12	XS618B1PAM12	XS530BLPAM12	XS630B1PAM12
	NPN	cable	XS518BLNAL2	XS618B1NAL2	XS530BLNAL2	XS630B1NAL2
		connector	XS518BLNAM12	XS618B1NAM12	XS530BLNAM12	XS630B1NAM12
DC2	cable	XS518B1DAL2	XS618B1DAL2	XS530B1DAL2	XS630B1DAL2	
	connector	XS518B1DAM12	XS618B1DAM12	XS530B1DAM12	XS630B1DAM12	
AC/DC	cable	XS518B1MAL2	XS618B1MAL2	XS530B1MAL2	XS630B1MAL2	
		connector	XS518B1MAU20	XS618B1MAU20	XS530B1MAU20	XS630B1MAU20
	Output function	NO	A		A	
		NC	B		B	
NO + NC		(short only) C		(short only) C		

Accessories

M8	XSZB108
M12	XSZB112
M18	XSZB118
M30	XSZB130



Screw terminal M 20



Connector M 12, 4 pin

Flush mountable

Flush adaptable mountable

			U 80x80x26 mm	
Sensing distance			40 mm	
DC3	PNP	cable	XS7D1A1PAL2	
		connector	XS7D1A1PAM12	
	NPN	cable	XS7D1A1NAL2	
		connector	XS7D1A1NAM12	
DC2	cable	XS7D1A1DAL2		
	connector	XS7D1A1DAM12		
Sensing distance			60 mm	
DC3	PNP	cable	XS8D1A1PAL2	
		connector	XS8D1A1PAM12	
	NPN	cable	XS8D1A1NAL2	
		connector	XS8D1A1NAM12	
AC/DC	cable	XS8D1A1MAL2		
	connector	XS8D1A1MAU20		
Output function	NO	A		
	NC	B		

Cubic

			U 40x40x117 mm		Flush mountable		Non flush mountable	
Sensing distance					20 mm	40 mm		
DC3	PNP	NO+NC	XS8C2A1PCM12	XS8C2A4PCM12				
		NO+NC	XS8C2A1NCM12	XS8C2A4NCM12				
	DC2	NO	XS8C2A1DAM12	XS8C2A4DAM12				
		NO	XS8C2A1MAU20	XS8C2A4MAU20				
DC4	PNP	NO+NC	XS8C4A1PCP20	XS8C4A4PCP20				
		NO+NC	XS8C4A1NCP20	XS8C4A4NCP20				
	DC2	NO or NC	XS8C4A1DP P20	XS8C4A4DP P20				
		NO or NC	XS8C4A1MP P20	XS8C4A4MP P20				
Select the type of connection			M20	P20	P20			
			PG13	G13	G13			
			1/2" NPT	N12	N12			

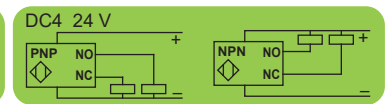
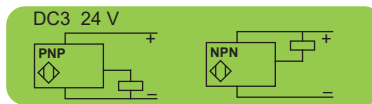

Accessories

For 26x26	XSZBE00	XSZBE90
For 40x40	XSZBC00	XSZBC90

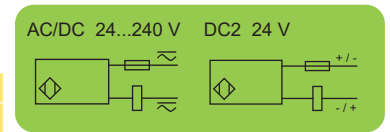

Rotation monitoring: XSAV Range

Choose: **1** Speed > **2** Output Type > Reference

			Sensing distance		Low Speed	High Speed
					10 mm	10 mm
M30	Flush	cable	Output type	DC3-PNP	XSAV11373	XSAV12373
				AC/DC	XSAV11801	XSAV12801

Cabling XS

M12		PUR pre wired connectors (female) (1)		
		straight	elbowed	elbowed PNP LED
4 pin	2 m	XZCP1141L2	XZCP1241L2	XZCP1340L2
	5 m	XZCP1141L5	XZCP1241L5	XZCP1340L5
	10 m	XZCP1141L10	XZCP1241L10	XZCP1340L10

M12		Connectors (female)	
		straight	elbowed
4 pin	(2)	XZCC12FDM40B	XZCC12FCM40B
	(3)	XZCC12FDP40B	XZCC12FCP40B

(1) For a PVC cable, add the letter V after the P. Example: XZCpvpvvvv become

(2) Steel ring (3) Plastic ring

Photo-electrics: XU Range

XU miniature, cylindrical and hybrid model*

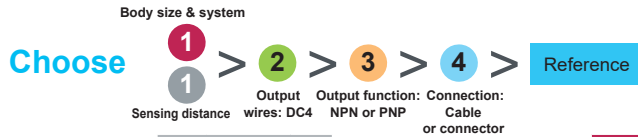

					M18 metal	M18 plastic	Hybrid	Miniature		
Diffuse 	1 m	DC4	PNP	cable	XUB5BPXNL2	XUB5APXNL2	XUN5APXNL2	1.9 m	XUM5APXBL2	
				connector 4P*	XUB5BPXNM12	XUB5APXNM12	XUN5APXNM12		XUM5APXBM8	
		NPN	cable	XUB5BNXNL2	XUB5ANXNL2	XUN5ANXNL2	XUM5ANXBL2			
			connector 4P	XUB5BNXNM12	XUB5ANXNM12	XUN5ANXNM12	XUM5ANXBM8			
	DC4	PNP	NPN	cable	XUB5BPYNL2	XUB5APYNL2		1.1 m	XUM6APXBL2	
				connector 4P					XUM6APXBM8	
		NPN	cable				XUM6ANXBL2			
			connector 4P				XUM6ANXBM8			
	0.5 m	DC4	PNP	NPN	cable	XUB6BPXNL2	XUB6APXNL2	XUN6APXNL2	0.25 m	XUM6APXBL2
					connector 4P	XUB6BPXNM12	XUB6APXNM12	XUN6APXNM12		XUM6APXBM8
			NPN	cable	XUB6BNXNL2	XUB6ANXNL2	XUN6ANXNL2	XUM6ANXBL2		
				connector 4P	XUB6BNXNM12	XUB6ANXNM12	XUN6ANXNM12	XUM6ANXBM8		
DC4		PNP	NPN	cable	XUB6BPYNL2	XUB6APYNL2		0.3 m	XUM8APXBL2	
				connector 4P					XUM8APXBM8	
		NPN	cable	XUB8BPXNL2*	XUB8APXNL2*	XUN8APXNL2*	XUM8ANXBL2			
			connector 4P	XUB8BPXNM12*	XUB8APXNM12*	XUN8APXNM12*	XUM8ANXBM8			
Background Suppression 		0.3 m	DC4	PNP	cable	XUB8BPXNL2*	XUB8APXNL2*	XUN8APXNL2*	0.3 m	XUM8APXBL2
					connector 4P	XUB8BPXNM12*	XUB8APXNM12*	XUN8APXNM12*		XUM8APXBM8
			NPN	cable	XUB8BNXNL2*	XUB8ANXNL2*	XUN8ANXNL2*	XUM8ANXBL2		
				connector 4P	XUB8BNXNM12*	XUB8ANXNM12*	XUN8ANXNM12*	XUM8ANXBM8		
	DC4	PNP	NPN	cable	XUB9BPXNL2	XUB9APXNL2	XUN9APXNL2	8 m	XUM9APXBL2	
				connector 4P	XUB9BPXNM12	XUB9APXNM12	XUN9APXNM12		XUM9APXBM8	
		NPN	cable	XUB9BNXNL2	XUB9ANXNL2	XUN9ANXNL2	XUM9ANXBL2			
			connector 4P	XUB9BNXNM12	XUB9ANXNM12	XUN9ANXNM12	XUM9ANXBM8			
	Accessory: Reflector					XUZC50	XUZC50	XUZC50	XUZC50	
	Thru-beam receiver 	30 m	DC4	PNP	cable	XUB2BPXNL2R	XUB2APXNL2R	XUN2APXNL2R	30 m	XUM2APXBL2R
					connector 4P	XUB2BPXNM12R	XUB2APXNM12R	XUN2APXNM12R		XUM2APXBM8R
			NPN	cable	XUB2BNXNL2R	XUB2ANXNL2R	XUN2ANXNL2R	XUM2ANXBL2R		
connector 4P				XUB2BNXNM12R	XUB2ANXNM12R	XUN2ANXNM12R	XUM2ANXBM8R			
DC4		PNP	NPN	io-Link	XUB2BPYNM12R	XUB2APYNM12R		30 m	XUM2AKXNL2T	
				Transmitter	cable	XUB2BKXNL2T	XUB2AKXNL2T		XUN2AKXNL2T	XUM2AKXNM12T
		NPN	connector 4P	XUB2BKXNM12T	XUB2AKXNM12T	XUN2AKXNM12T	XUM2AKXBL2T			
			io-Link	XUB2BPYNM12R	XUB2APYNM12R		XUM2ANXBL2			
Thru-beam 		30 m	DC4	PNP	cable	XUB2BPXNL2	XUB2APXNL2	XUN2APXNL2	30 m	XUM2APXBL2
					connector 4P	XUB2BPXNM12	XUB2APXNM12	XUN2APXNM12		XUM2APXBM8
			NPN	cable	XUB2BNXNL2	XUB2ANXNL2	XUN2ANXNL2	XUM2ANXBL2		
				connector 4P	XUB2BNXNM12	XUB2ANXNM12	XUN2ANXNM12	XUM2ANXBM8		
	io-Link					XUB2BPYNM12R	XUB2APYNM12R		XUM2ANXBM8	

*Product available in Q4 2024

Multimode					DC3		PNP		cable		XUB0BPSNL2		XUB0APSNL2		XUM0APXSAL2							
	Transmitter	DC	Output function	NO or NC	Sensing distance	Background Sup: 0.12 m	Diffuse: 0.3 m	Polarized reflex: 3 m	Thru-beam: 20 m	cable	connector 4P	XUB0BKSNL2T	XUB0AKSNL2T	XUM0AKXSAL2T	XUM0AKSAM8T	BGS: 0.1 m	D: 0.4 m					
																		NPN	cable	XUB0BNSNL2	XUB0ANSNL2	XUM0ANSAL2
																			connector 4P	XUB0BNSNM12	XUB0ANSNM12	XUM0ANSAM8
																		P: 3 m TB: 10 m				

Photo-electrics: XU Range

		Sensing distance		Compact 50x50 mm		Compact 92x71 mm						
	Diffuse	1 m	DC3	PNP	cable	XUK5APANL2	2.1 m	DC3	PNP	terminals	XUX5APANT16	
					connector 4P	XUK5APANM12				connector 4P	XUX5APANM12	
				NPN	cable	XUK5ANANL2				terminals	XUX5ANANT16	
					connector 4P	XUK5ANANM12				connector 4P	XUX5ANANM12	
				AC/DC	Relay	cable				XUK5ARCNL2	terminals	XUX5ARCNT16
Output function		NO		A		A						
		NC		B		B						
	Polarized Reflex	5 m	DC3	PNP	cable	XUK9APANL2	11 m	DC3	PNP	terminals	XUX9APANT16	
					connector 4P	XUK9APANM12				connector 4P	XUX9APANM12	
				NPN	cable	XUK9ANANL2				terminals	XUX9ANANT16	
					connector 4P	XUK9ANANM12				connector 4P	XUX9ANANM12	
				AC/DC	Relay	cable				XUK9ARCNL2	terminals	XUX9ARCNT16
Accessory: Reflector				XUZC50		XUZC50						
	Reflex	7 m	DC3	PNP	cable	XUK1APANL2	14 m	DC3	PNP	terminals	XUX1APANT16	
					connector 4P	XUK1APANM12				connector 4P	XUX1APANM12	
				NPN	cable	XUK1ANANL2				terminals	XUX1ANANT16	
					connector 4P	XUK1ANANM12				connector 4P	XUX1ANANM12	
				AC/DC	Relay	cable				XUK1ARCNL2	terminals	XUX1ARCNT16
Accessory: Reflector				XUZC50		XUZC50						
	Thru-beam	30 m	DC3	PNP	cable	XUK2APANL2R	40 m	DC3	PNP	terminals	XUX2APANT16R	
					connector 4P	XUK2APANM12R				connector 4P	XUX2APANM12R	
				NPN	cable	XUK2ANANL2R				terminals	XUX2ANANT16R	
					connector 4P	XUK2ANANM12R				connector 4P	XUX2ANANM12R	
				AC/DC	Relay	cable				XUK2AKSNL2T	terminals	XUX0AKSAT16T
						connector 4P				XUK2AKSNM12T	connector 4P	XUX0AKSAM12T
AC/DC	Relay	cable	XUK2ARCNL2R	terminals	XUX2ARCNT16R							
		cable	XUK2ARCNL2T	terminals	XUX0ARCTT16T							

Multimode		DC3 PNP/NPN		DC3 PNP/NPN					
	Background suppression (BGS) Diffuse (D) Polarised reflex (P) Thru-beam (TB)	AC/DC	Relay	cable	XUK0ARCTL2	AC/DC	Relay	terminals	XUX0ARCTT16
				connector 4P	XUK0AKSAM12			connector 4P	XUX0AKSAM12
		Background Suppression: 0.28 m		Diffuse: 0.8 m		Background Suppression: 1.3 m		Diffuse: 2 m	
		Polarised reflex: 4 m		Thru-beam: 30 m		Polarised reflex: 11 m		Thru-beam: 40 m	
Accessory: Transmitter		DC		cable	XUK0AKSAL2T	DC		terminals	XUX0AKSAT16T
				connector 4P	XUK0AKSAM12T			connector 4P	XUX0AKSAM12T
				AC/DC	cable			XUK0ARCTL2T	AC/DC

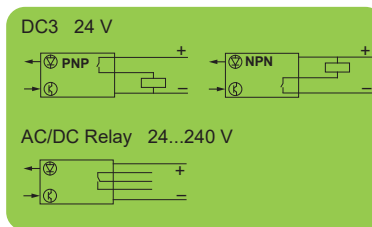

PUR pre wired connectors (female) (1)				Connectors (female)			
M12		straight	elbowed	M12	straight	elbowed	
4 pin	2 m	XZCP1141L2	XZCP1241L2	4 pin (2)	XZCC12FDM40B	XZCC12FCM40B	
	5 m	XZCP1141L5	XZCP1241L5		4 pin (3)	XZCC12FDP40B	XZCC12FCP40B
	10 m	XZCP1141L10	XZCP1241L10				

(1) For a PVC cable, add the letter V after the P. Example: XZCPpppppp become XZCPVpppppp

(2) Steel ring (3) Plastic ring

Photo-electrics applicative

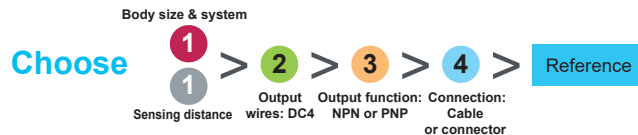

Color sensors



Light type	Sensing distance	Output type	Connection	Output function	Compact	Miniature	Sub-miniature
White	60 mm	DC5	PNP/NPN /IO-LINK	M12 5-Pin	XUKCBSAYM12		
	150 mm				XUKCBLAYM12		

RGB LED	12 mm	DC4	PNP/NPN/IO-LINK	M8 4-Pin		XUMRACAYM8	
---------	-------	-----	-----------------	----------	--	------------	--

Color Mark Reader



RGB	12 mm	DC4	PNP/NPN/IO-LINK	M8 4-Pin		XUMRAGAYM8	
				M12 4-Pin, 150 mm		XUMRAGAYP015	
White led	12 mm	DC4	PNP/NPN/IO-LINK	M8 4-Pin		XUMRAWAYM8	
				M12 4-Pin, 150 mm		XUMRAWAYP015	
Laser	250 mm	DC4	PNP/NPN/IO-LINK	M8 4-Pin		XUM5ALAYM8	
				M12 4-Pin, 150 mm		XUM5ALAYP015	
				Cable, 2 m, 4-Wire		XUM5ALAYL2	

Transparent



Red light	2000 mm	DC4	PNP/NPN/IO-LINK	M8 4-Pin		XUMTARAYM8	
				M12 4-Pin, 150 mm		XUMTARAYP015	
				Cable, 2 m, 4-Wire		XUMTARAYL2	

Accessory: Reflector						XUZC50	XUZC50
----------------------	--	--	--	--	--	--------	--------

Blue light	50 mm	DC4	PNP	M8 4-Pin, 200 mm			XUT7ABPXP02
				Cable, 2 m, 4-Wire			XUT7ABPXL2

	80 mm	DC4	PNP	M8 4-Pin		XUM7ABPXM8	
--	-------	-----	-----	----------	--	------------	--

				Cable, 2 m, 4-Wire		XUM7ABPXL2	
--	--	--	--	--------------------	--	------------	--

	100 mm	DC4	PNP/NPN/IO-LINK	M8 4-Pin, 200 mm			XUT8ABAYP02
--	--------	-----	-----------------	------------------	--	--	-------------

				Cable, 2 m, 4-Wire			XUT8ABAYL2
--	--	--	--	--------------------	--	--	------------

	200 mm	DC4	PNP/NPN/IO-LINK	M8 4-Pin		XUM8ABAYM8	
--	--------	-----	-----------------	----------	--	------------	--

				M12 4-Pin, 150 mm		XUM8ABAYP015	
--	--	--	--	-------------------	--	--------------	--

	1200 mm	DC4	PNP	M12 4-Pin	XUK8ABPXM12		
--	---------	-----	-----	-----------	-------------	--	--

Laser



Diffuse	250 mm	DC4	PNP/NPN/IO-LINK	M8 4-Pin		XUM5ALAYM8	
				M12 4-Pin, 150 mm		XUM5ALAYP015	
				Cable, 2 m, 4-Wire		XUM5ALAYL2	

BGS	70 mm	DC4	PNP/NPN/IO-LINK	M8 4-Pin, 200 mm			XUT8ALAYP02
				Cable, 2 m, 4-Wire			XUT8ALAYL2

	150 mm	DC4	PNP/NPN/IO-LINK	M8 4-Pin		XUM8ALAYM8	
--	--------	-----	-----------------	----------	--	------------	--

				M12 4-Pin, 200 mm		XUM8ALAYP015	
--	--	--	--	-------------------	--	--------------	--

				Cable, 2 m, 4-Wire		XUM8ALAYL2	
--	--	--	--	--------------------	--	------------	--

Reflex	10000 mm	DC4	PNP/NPN/IO-LINK	M8 4-Pin		XUM9ALAYM8	
				M12 4-Pin, 200 mm		XUM9ALAYP015	
				Cable, 2 m, 4-Wire		XUM9ALAYL2	

			PNP				
--	--	--	-----	--	--	--	--

	3000 mm	DC4		M8 4-Pin, 200 mm			XUT9ALPXP02
--	---------	-----	--	------------------	--	--	-------------

				Cable, 2 m, 4-Wire			XUT9ALPXL2
--	--	--	--	--------------------	--	--	------------

BSG Blue Light

Accessory: Reflector High precision

						XUZC50HP	XUZC50HP
--	--	--	--	--	--	----------	----------

Fixed	50 mm	DC4	PNP	M8 4-Pin, 200 mm			XUT7ABPXP02
				Cable, 2 m, 4-Wire			XUT7ABPXL2

	80 mm	DC4	PNP	M8 4-Pin		XUM7ABPXM8	
--	-------	-----	-----	----------	--	------------	--

				Cable, 2 m, 4-Wire		XUM7ABPXL2	
--	--	--	--	--------------------	--	------------	--

Teach	100 mm	DC4	PNP/NPN/IO-LINK	M8 4-Pin, 200 mm			XUT8ABAYP02
				Cable, 2 m, 4-Wire			XUT8ABAYL2

	200 mm	DC4	PNP/NPN/IO-LINK	M8 4-Pin		XUM8ABAYM8	
--	--------	-----	-----------------	----------	--	------------	--

				M12 4-Pin, 150 mm		XUM8ABAYP015	
--	--	--	--	-------------------	--	--------------	--

	1200 mm	DC4	PNP	M12 4-Pin	XUK8ABPXM12		
--	---------	-----	-----	-----------	-------------	--	--



Accessories

XZ (...) M8:
Connector M8 4 pin

XZ (...) M12:
Connector M12 4 pin

Reflectors



XUZC24



XUZC80



XUZC50



XUZC50HP



XUZC100



XUZC50CR

Cabling XU

M12		PUR pre wired connectors (female) (1)		
		straight	elbowed	elbowed PNP LED
4 pin	2 m	XZCP1141L2	XZCP1241L2	XZCP1340L2
	5 m	XZCP1141L5	XZCP1241L5	XZCP1340L5
	10 m	XZCP1141L10	XZCP1241L10	XZCP1340L10

(1) For a PVC cable, add the letter V after the P.
Example: XZCP1141L2 become XZCPV1141L2 for a PVC version

Cabling XU

M8		PUR pre wired connectors (female) (1)	
		straight	elbowed
4 pin	2 m	XZCP0941L2	XZCP1041L2
	5 m	XZCP0941L5	XZCP1041L5
	10 m	XZCP0941L10	XZCP1041L10

(1) For a PVC cable, add the letter V after the P.
Example: XZCP0941L2 become XZCPV0941L2



XUZARM

Dovetail clamp
Supplied with 2x M3 screws

Compatible with

- XUM*A*AYM8
- XUM*A*AYP015
- XUM*A*AYL2
- XUM7ABPX**



XUZARS

Dovetail clamp
Supplied with 2x M3 screws

Compatible with

- XUT7ABPX**
- XUT8A*AY**
- XUT9ABPX**



XUZARK

Dovetail clamp
Supplied with 1x M3 screws

Compatible with

- XUKCB*AYM12
- XUK8ABPXM12



XUZASS

Mounting bracket
Supplied with 2x M3 screws

Compatible with

- XUT7ABPX**
- XUT8A*AY**
- XUT9ABPX**

Other fixings

Single bracket

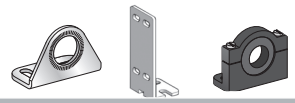

	standard	with ball joint
	XUB	XUZA118 (stainless steel)
XUM	XUZA50	–
XUK	XUZA51	–
XUX	XUZ2000	–

Ultrasonics: XX Range

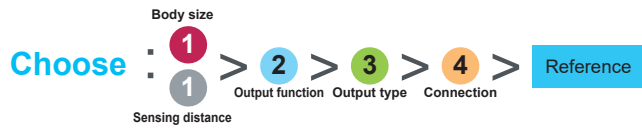

			M12		M18		M18 plastic (2)		M18 brass (2)		M18 stainless (2)		M18 metal	
Sensing distance			0.05 m	0.1 m	0.15 m	0.5 m Adjust. (1)	1 m Adjust. (1)	1 m Adjust. (1)	1 m Adjust. (1)	1 m Adjust. (1)	1 m Adjust. (1)	1 m Adjust. (1)	0.05 m	
Connectors/Cables			M8 4 pin	M8 3 pin	M12 4 pin	M12 4 pin	M12 5 pin	M12 5 pin	M12 5 pin	M12 5 pin	M12 5 pin	M12 5 pin	M12 4 pin	
NO	DC4	PNP/NPN	XX512A1KAM8		XX518A1KAM12									
	DC3	PNP		XX512A2PAM8		XX518A3PAM12							XXV18B1PAM12	
		NPN		XX512A2NAM8		XX518A3NAM12							XXV18B1NAM12	
NO or NC	DC3	PNP					XXS18P1PM12	XXS18B1PM12	XXS18S1PM12					
							XXA18P1PM12	XXA18B1PM12	XXA18S1PM12					
Analog		4...20 mA				XX918A3C2M12	XXS18P1AM12	XXS18B1AM12	XXS18S1AM12					
							XXA18P1AM12	XXA18B1AM12	XXA18S1AM12					
							XXS18P1VM12	XXS18B1VM12	XXS18S1VM12					
							XXA18P1VM12	XXA18B1VM12	XXA18S1VM12					
		0...10 V				XX918A3F1M12	XXS18P1VM12	XXS18B1VM12	XXS18S1VM12					
							XXA18P1VM12	XXA18B1VM12	XXA18S1VM12					

(1) Adjustable with XXZPB100

(2) Configurable with XXZBOX01 by software

S = straight A = angled



			M30 plastic (2)				M30 Brass (2)			M30 Stainless (2)		
Sensing distance			1 m Adjust. (1)	2 m Adjust. (1)	4 m Adjust. (1)	8 m Adjust. (3)	1 m Adjust. (1)	2 m Adjust. (1)	4 m Adjust. (1)	1 m Adjust. (1)	2 m Adjust. (1)	4 m Adjust. (1)
Connectors			M12 5-pin	M12 5-pin	M12 5-pin	M12 5-pin	M12 5-pin	M12 5-pin	M12 5-pin	M12 5-pin	M12 5-pin	M12 5-pin
NO or NC	DC3	PNP	XXS30P1PM12	XXS30P2PM12	XXS30P4PM12		XXS30B1PM12	XXS30B2PM12	XXS30B4PM12	XXS30S1PM12	XXS30S2PM12	XXS30S4PM12
			XXA30P1PM12	XXA30P2PM12			XXA30B1PM12	XXA30B2PM12		XXA30S1PM12	XXA30S2PM12	
	DC4	2 x PNP 2 x NPN				XXS30P8PM12				XXA30S1PM12	XXA30S2PM12	
							XXS30P8NPM12					
Analog	DC3	4...20mA	XXS30P1AM12	XXS30P2AM12	XXS30P4AM12		XXS30B1AM12	XXS30B2AM12	XXS30B4AM12	XXS30S1AM12	XXS30S2AM12	XXS30S4AM12
			XXA30P1AM12	XXA30P2AM12			XXA30B1AM12	XXA30B2AM12		XXA30S1AM12	XXA30S2AM12	
		0...10V	XXS30P1VM12	XXS30P2VM12	XXS30P4VM12		XXS30B1VM12	XXS30B2VM12	XXS30B4VM12	XXS30S1VM12	XXS30S2VM12	XXS30S4VM12
			XXA30P1VM12	XXA30P2VM12			XXA30B1VM12	XXA30B2VM12		XXA30S1VM12	XXA30S2VM12	
Analog + NO or NC	DC4	4...20 mA + PNP 0...10V + PNP				XXS30P8APM12						
						XXS30P8VPM12						

(1) Adjustable with XXZPB100

(2) Configurable with XXZBOX01 by software

(3) Push-button integrated on the product

S = straight A = angled



			Flat 7.6x19x33		Flat 16x30x74		Flat 60x30x18 + M18	
Sensing distance			0.1 m	0.25 m	0.5 m Adjust.	0.5 m Adjust.	0.5 m Adjust.	0.5 m Adjust.
Connectors			M12 4 pin	M12 4 pin	M12 4 pin	M12 4 pin	M12 4 pin	M12 4 pin
NO	DC3	PNP	XX7F1A2PAL01M12	XX7K1A2PAM12			XX7V1A1PAM12 (1)	
			NPN	XX7F1A2NAL01M12	XX7K1A2NAM12			XX7V1A1NAM12 (1)
Analog		4...20 mA 0...10 V					XX9V1A1C2M12 (1)	
							XX9V1A1F1M12 (1)	

(1) Adjustable with XXZPB100

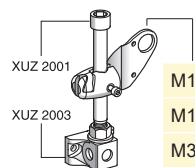
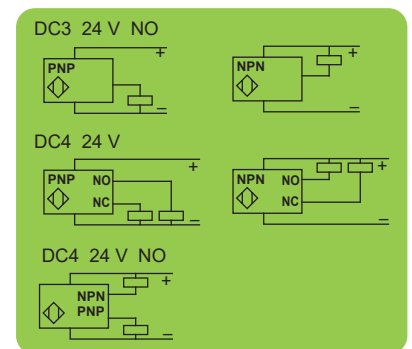

M12	XUZB2012
M18	XUZB2003
M30	XUZB2030

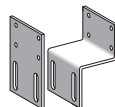

For XX7K

Flat	XXZ3074F
Cranked	XXZ3074S

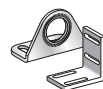

M12	XXZ12
M18	XUZA118
M30	XXZ30
XX7F	XXZ1933

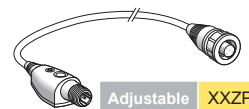

Adjustable XXZPB100

Forks: XUV Range

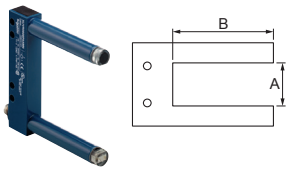

			A: 50 mm / B: 60 mm	A: 80 mm / B: 60 mm	A: 120 mm / B: 120 mm	A: 180 mm / B: 120 mm
DC3	PNP	M8 3 pin	XUVR0605P ^A NM8	XUVR0608P ^A NM8	XUVR1212P ^A NM8	XUVR1218P ^A NM8
	NPN	M8 3 pin	XUVR0605N ^A NM8	XUVR0608N ^A NM8	XUVR1212N ^A NM8	XUVR1218N ^A NM8
Output function		NO		A	A	A
		NC		B	B	B

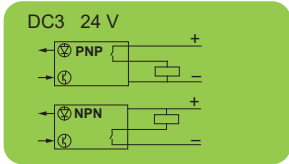

Cabling XX & XUV

		PUR pre wired connectors (female) (1)			Connectors (female)		
M8		straight	elbowed	elbowed PNP LED	M12	straight	elbowed
3 pin	2 m	XZCP0566L2	XZCP0666L2		(2) 4 pin	XZCC12FDM40B	XZCC12FCM40B
	5 m	XZCP0566L5	XZCP0666L5		(3) 4 pin	XZCC12FDP40B	XZCC12FCP40B
	10 m	XZCP0566L10	XZCP0666L10		(2) Steel ring (3) Plastic ring		
4 pin	2 m	XZCP0941L2	XZCP1041L2				
	5 m	XZCP0941L5	XZCP1041L5				
	10 m	XZCP0941L10	XZCP1041L10				
M12					Connectors (male)		
4 pin	2 m	XZCP1141L2	XZCP1241L2	XZCP1340L2	M12	straight	elbowed
	5 m	XZCP1141L5	XZCP1241L5	XZCP1340L5	4 pin	XZCC12MDM40B	XZCC12MCM40B
	10 m	XZCP1141L10	XZCP1241L10	XZCP1340L10	5 pin	XZCC12MDM50B	XZCC12MCM50B

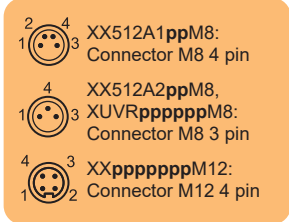

(1) For a PVC cable, add the letter V after the P. Example: XZCPpppppp become XZCPVpppppp

RFID Systems: XG Range



Compact 40x40mm		
Sensing distance 18-70mm		
PNP output with 1 pulse	Modbus RTU	
Blue body, connector on back	White body with remote lights, connector on back	Stand alone
XGCS491B201	XGCS49LB201	XGCS490B201

(1) compatible with ZB5AZ905 and XGSZCNFAC

Compact 40x40mm	Compact 80x80mm	
Sensing distance 18-70mm	Sensing distance 20-100mm	
Modbus RTU		Modbus TCP & Ethernet/IP
Blue body, connector and cable by side		
XGCS4901201	XGCS8901201	XGCS850C201

Accessories	XGSZCNFAC	Set of configuration badges	XZCC12MDB50R	M12 connector
	XGSZCNF01	Configuration badge	XZCPV11V2L2/5/10	M12 pre-wired connector
	XGHB90E341	Pack of user's badges	XZCPV12V2L2/5/10	M12 pre-wired connector
	XGHBPB3345	Key fob tag		

Note: For our complete range of sensor solutions, visit www.tesensors.com

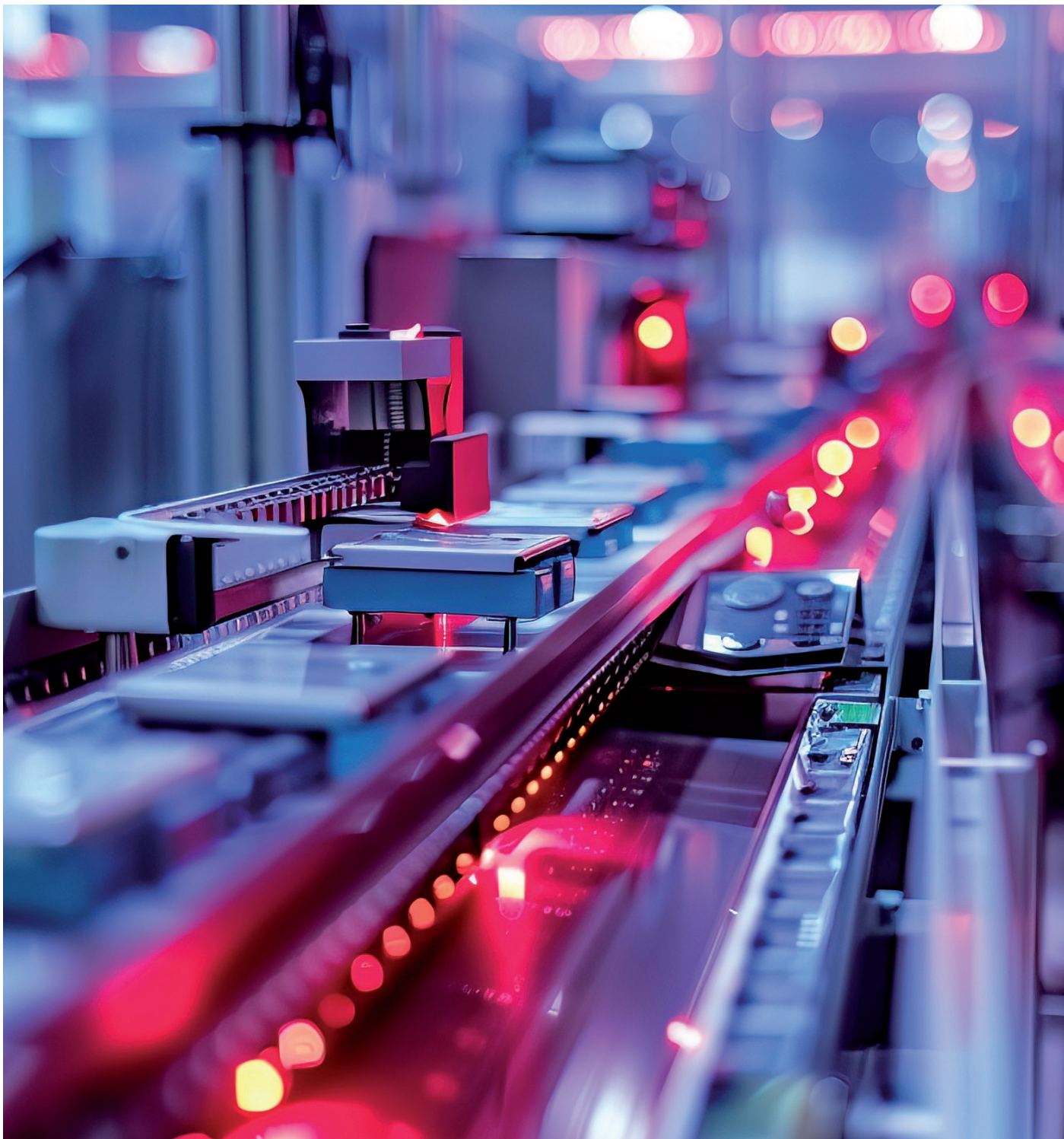

Discover our complete offer: www.telemecaniquesensors.com or contact your local sales agency

TMSS France SAS

Share capital: 366 931 214 euros
2 Avenue Gambetta - Tour Egho
92400 Courbevoie
908 125 255 RCS de Nanterre
www.telemecaniquesensors.com

The information provided in this documentation contains general descriptions and/or technical characteristics of the performance of the products contained herein. As standards, specifications and design change from time to time, please ask for confirmation of the information given in this publication. Neither TMSS France nor any of its subsidiaries or other affiliated companies shall be responsible or liable for misuse of the information contained in this document.

Telemecanique™ Sensors is a trademark of Schneider Electric Industries SAS used under license by TMSS France. Any other brands or trademarks referred to in this document are property of TMSS France or, as the case may be, of its subsidiaries or other affiliated companies. All other brands are trademarks of their respective owners.

As standards, specifications and design change from time to time, please ask for confirmation of the information given in this publication

© 2024, TMSS France, All Rights Reserved